

REV.	ECN.NO.	MODIFY.CONTENT	DATE
A		初版发行	10/25'17
B	GE18010**	增加其他视图	01/12'18

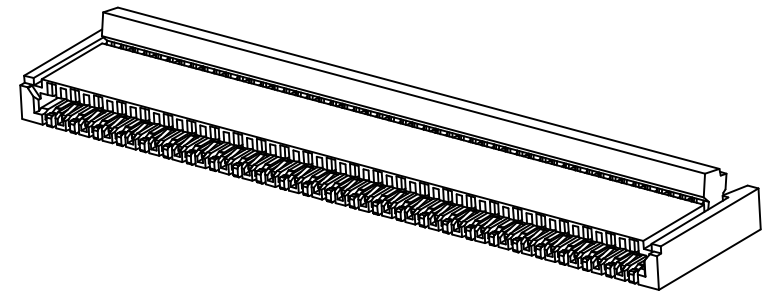
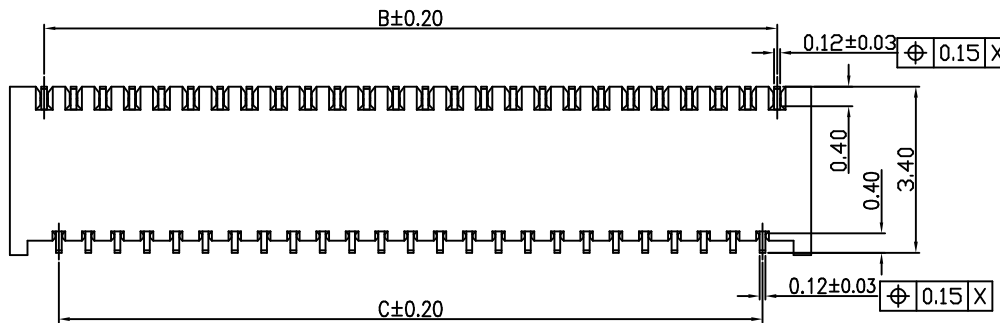
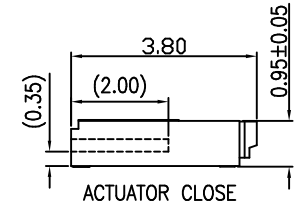
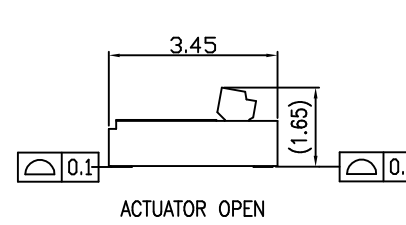
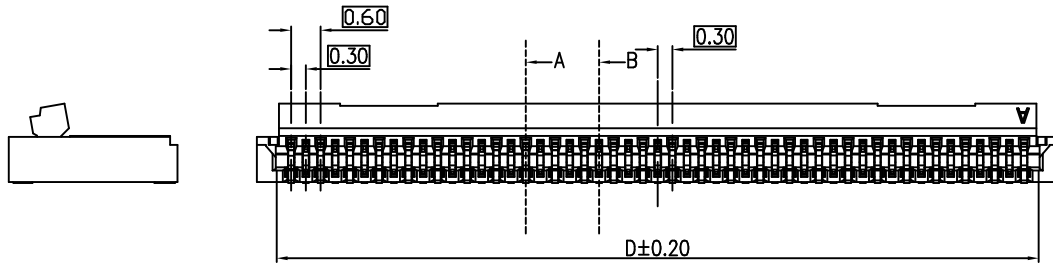
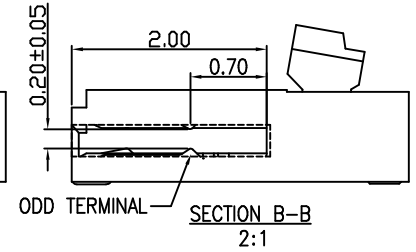
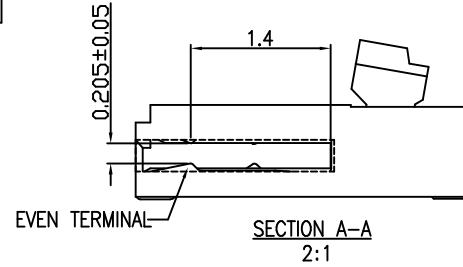
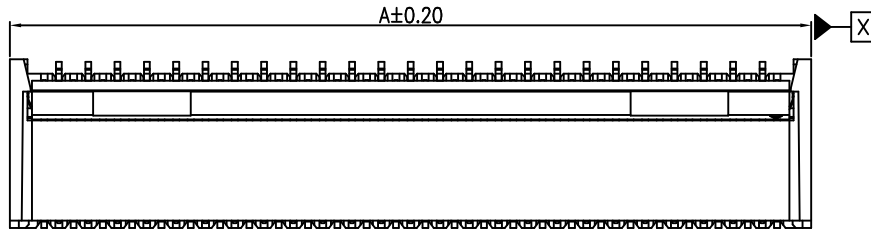

GENERAL TOLERANCE		DRAWN	Xiaohui.song	Oct.25-17	SCALE	PART NO.	1F03006***C03-**
X.±0.30	x.'±1°	CHECKED	Cunfa.lai	Oct.25-17	20/3	TITLE	0.3 PITCH FPC CONNECTOR
.X±0.25	.x'±0.1°	APPROVED	Qunyu.li	Oct.25-17	UNITS	mm	成品SPEC图
.XX±0.20		File NO.	F0300601S				
.XXX±0.10		REV.					
SHEET	1/2	Q'TY	1	B	蘇州祥龍嘉業電子科技股份有限公司 Goldenconn Electronics Technology Co.,LTD		

注：此文件为双方检验的唯一标准

REV.	ECN.NO.	MODIFY.CONTENT	DATE
A		初版发行	10/25'17
B	GE18010**	增加其他视图	01/12'18

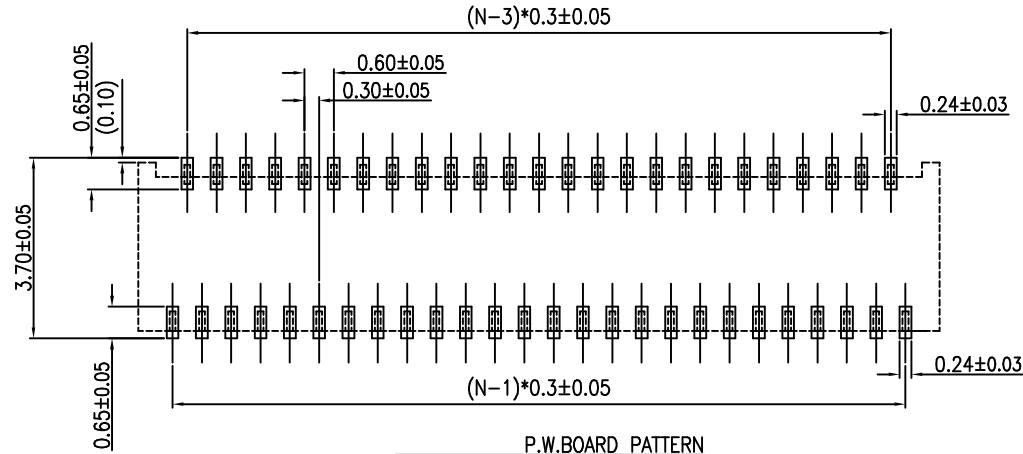

P.W. BOARD PATTERN
RECOMMENDED METAL MASK THICKNESS 0.1mm

NOTES:

Insulator: LCP UL 94V-0(Color: Natural)
 Actuator: PA9T UL 94V-0(Color: Black)
 Terminal: phosphor copper C5240 Plating:
 Gold plating at contact and solder area over all Ni 40u"min plating
 Current Rating: 0.3A AC/DC
 Voltage Rating: 50V AC/DC Max
 Temperature Range: -40°C~+105°C
 Contact Resistance: 100 mΩ Max
 Insulation Resistance: 50 MΩ Min
 Withstanding Voltage: 125V AC/minute

Gold plating — 1F03006 * ** C 0 3 -**
 H:3u" min
 E:5u" min
 PIN number —
 00:Rohs
 HF:HALOGEN FREE
 Reel packing
 Natural color

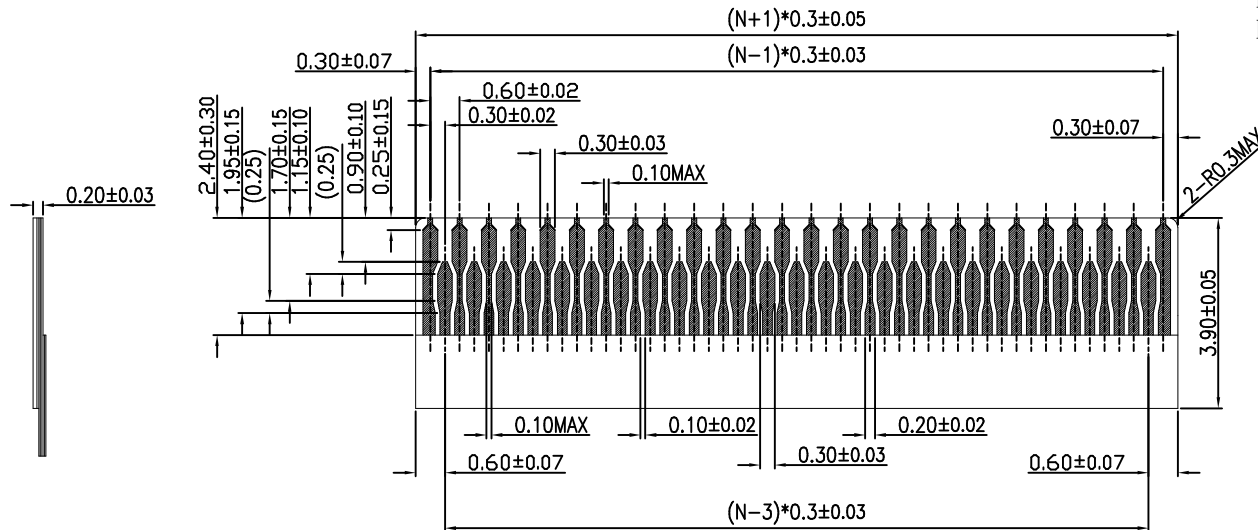

APPLY FPC RECOMMENDED DIM
(THICKNESS 0.20±0.03)

CIRCUITES	DIMENSION			
	A	B	C	D
11	4.4	3.0	2.4	3.6
19	6.8	5.4	4.8	6.0
23	8.0	6.6	6.0	7.2
25	8.6	7.2	6.6	7.8
33	11.0	9.6	9.0	10.2
37	12.2	10.8	10.2	11.4
39	12.8	11.4	10.8	12.0
41	13.4	12.0	11.4	12.6
45	14.6	13.2	12.6	13.8
51	16.4	15.0	14.4	15.6
61	19.4	18.0	17.4	18.6

GENERAL TOLERANCE		DRAWN	Xiaohui.song	Oct.25-17	SCALE	PART NO.	1F03006***C03-**
X.±0.30	x.'±1°	CHECKED	Cunfa.lai	Oct.25-17	20/3	TITLE	0.3 PITCH FPC CONNECTOR
.X±0.25	.x'±0.1°	APPROVED	Qunyu.li	Oct.25-17	UNITS	mm	成品SPEC图
.XX±0.20		File NO.	F0300601S				
.XXX±0.10		REV.	蘇州祥龍嘉業電子科技股份有限公司				
SHEET	2/2	Q'TY	1	B	Goldenconn Electronics Technology Co.,LTD		

注：此文件为双方检验的唯一标准

REV.	ECN.NO.	MODIFY.CONTENT	DATE
A		初版发行	10/25'17

- NOTES :
- MATERIAL :
COVER TAPE : P.S T=0.05
CARRIER TAPE : P.S T=0.30
REEL : PS
CARTON: CORRUGATED FIBER
 - DIMENSION :
REEL : SEE DRAWING
SHIPPING BOX: 350X350X300mm
 - QUANTITY : SEE TABLE
 - PEELING RESISTANCE : 30gf~100gf (for 12~56mm)
 - PEELING SPEED : 300mm/MINUTES

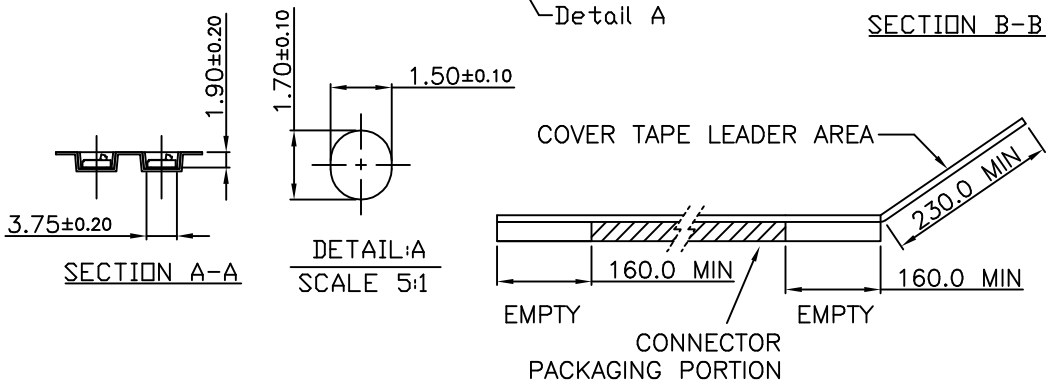
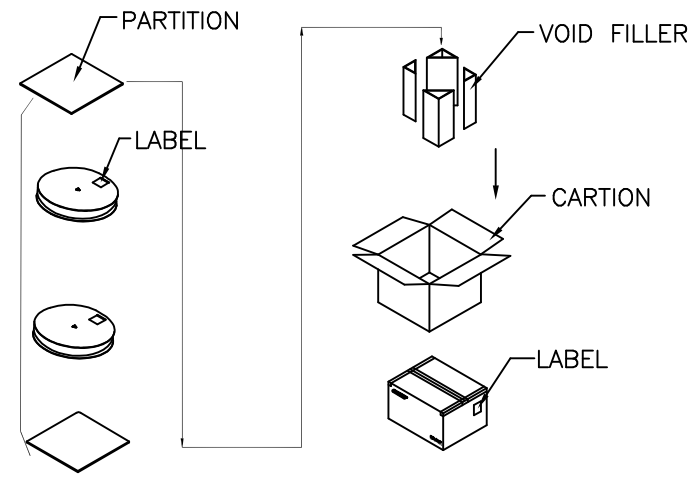
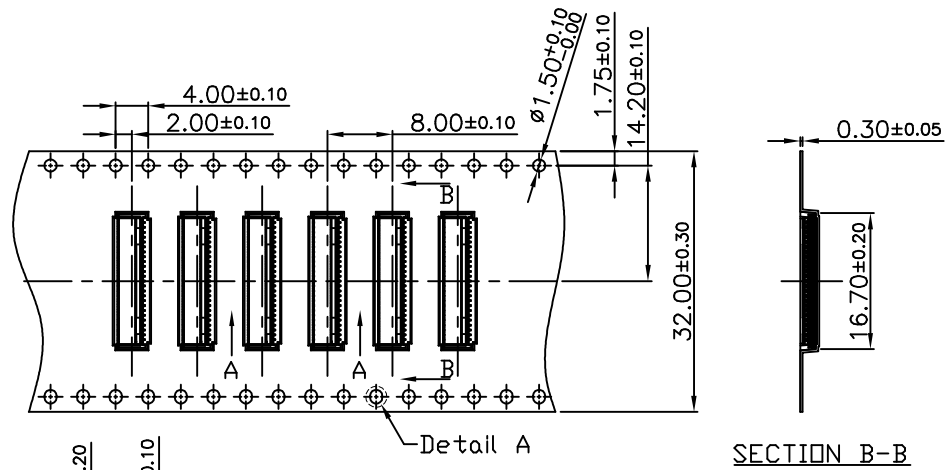
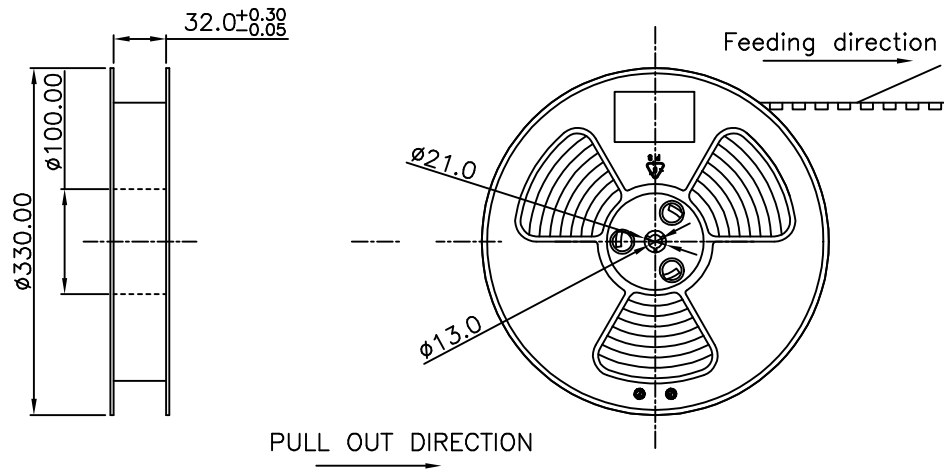

3800	3	11400
PCS/REEL	REEL/BOX	TOTAL Q'TY

GENERAL TOLERANCE	DRAWN	Xiaohui.song	Oct.25-17	SCALE	PART NO.	PACKF03006E51
X.±0.40	CHECKED	Cunfa.lai	Oct.25-17	N/A	TITLE	0.3 PITCH FPC CONNECTOR
.X±0.30	APPROVED	Qunyu.li	Oct.25-17	UNITS	mm	成品包装图
.XX±0.25	File NO.	P0300601S				
.XXX±0.10	REV.	蘇州祥龍嘉業電子科技股份有限公司 Goldenconn Electronics Technology Co.,LTD				
SHEET	1/1	Q'TY	1	A		

注：此文件为双方检验的唯一标准